



# 2025 NEWS

mizar

# Index

mizar

Elios	4
Flumen	10
Iris	16
Forma	22
Lucis Bollard	28
Oceano	34
Acus	38
Quantum	44

# Elios

ELIOS, the versatile spotlight designed to elevate your lighting projects. Available in a variety of elegant finishes, ELIOS delivers powerful illumination, perfect for highlighting plants or architectural facades. With a choice of white light in multiple color temperatures or dynamic RGBW lighting, and a range of beam angles from narrow to wide, ELIOS adapts seamlessly to any design vision.





# Elios

---

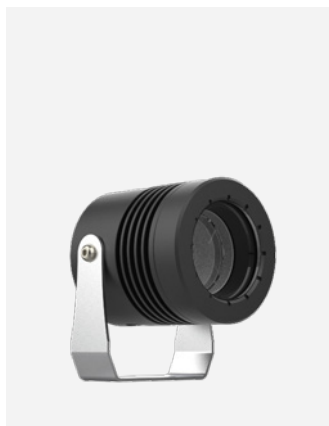

Elios 1.0



mizar

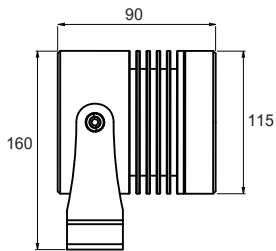

### Elios 1.0

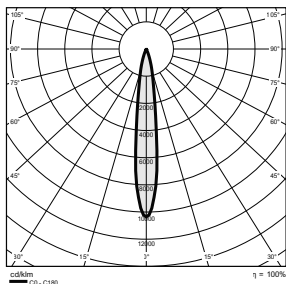

14°

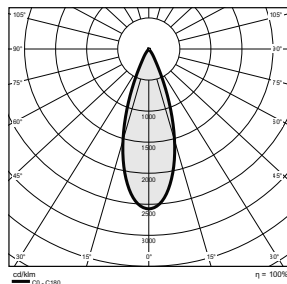

35°

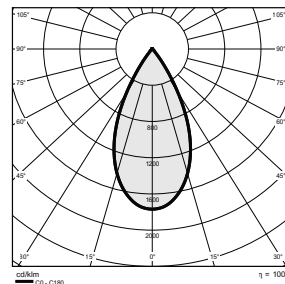

55°

Power	25W
Input Power Supply	48V
Ballast	Remote
Insulation class	III Class
IP rating	IP 66/67

IK rating	IK 10
Body material	Anodized 20μ aluminum
Bracket material	Stainless steel 316L
Finishing colour	Black anodized Anthracite RAL7016 Corten Dark green RAL6009 White RAL9003
Diffuser material	Tempered extra-clear glass
Operating temperature	-20 / +50°C

CCT	2700K 3000K 4000K
CRI	>90
Lumen output	up to 2075 lm
Beam angles	14° 35° 55°
Optical optional	None Honeycomb

# Elios

---

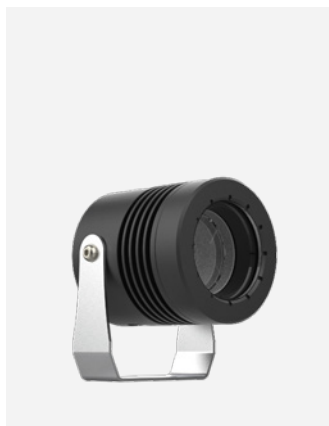

Elios 1.1 (RGBW)



mizar



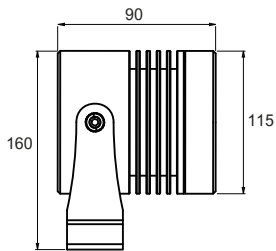

### Elios 1.1

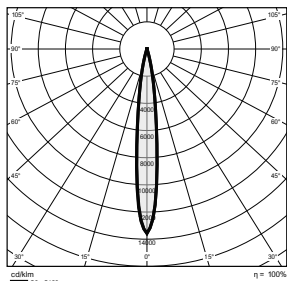

14°

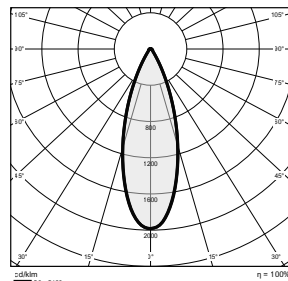

35°

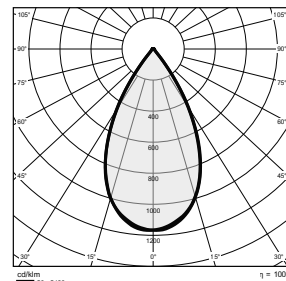

55°

Power	13W
Input Power Supply	24V
Ballast	Remote
Insulation class	III Class
IP rating	IP 66/67

IK rating	IK 10
Body material	Anodized 20μ aluminum
Bracket material	Stainless steel 316L
Finishing colour	Black anodized Anthracite RAL7016 Corten Dark green RAL6009 White RAL9003
Diffuser material	Tempered extra-clear glass
Operating temperature	-20 / +50°C

CCT	RGBW (4000K)
CRI	>80
Lumen output	up to 850 lm
Beam angles	14° 35° 55°
Optical optional	None Honeycomb

# Flumen

FLUMEN, the versatile spotlight designed to meet every lighting need. With a wide range of sizes and power options, FLUMEN allows you to customize its performance with external accessories, including visors, snoots, and color filters. These accessories pair seamlessly with four distinct TIR optics, offering endless possibilities to tailor the light to your project.

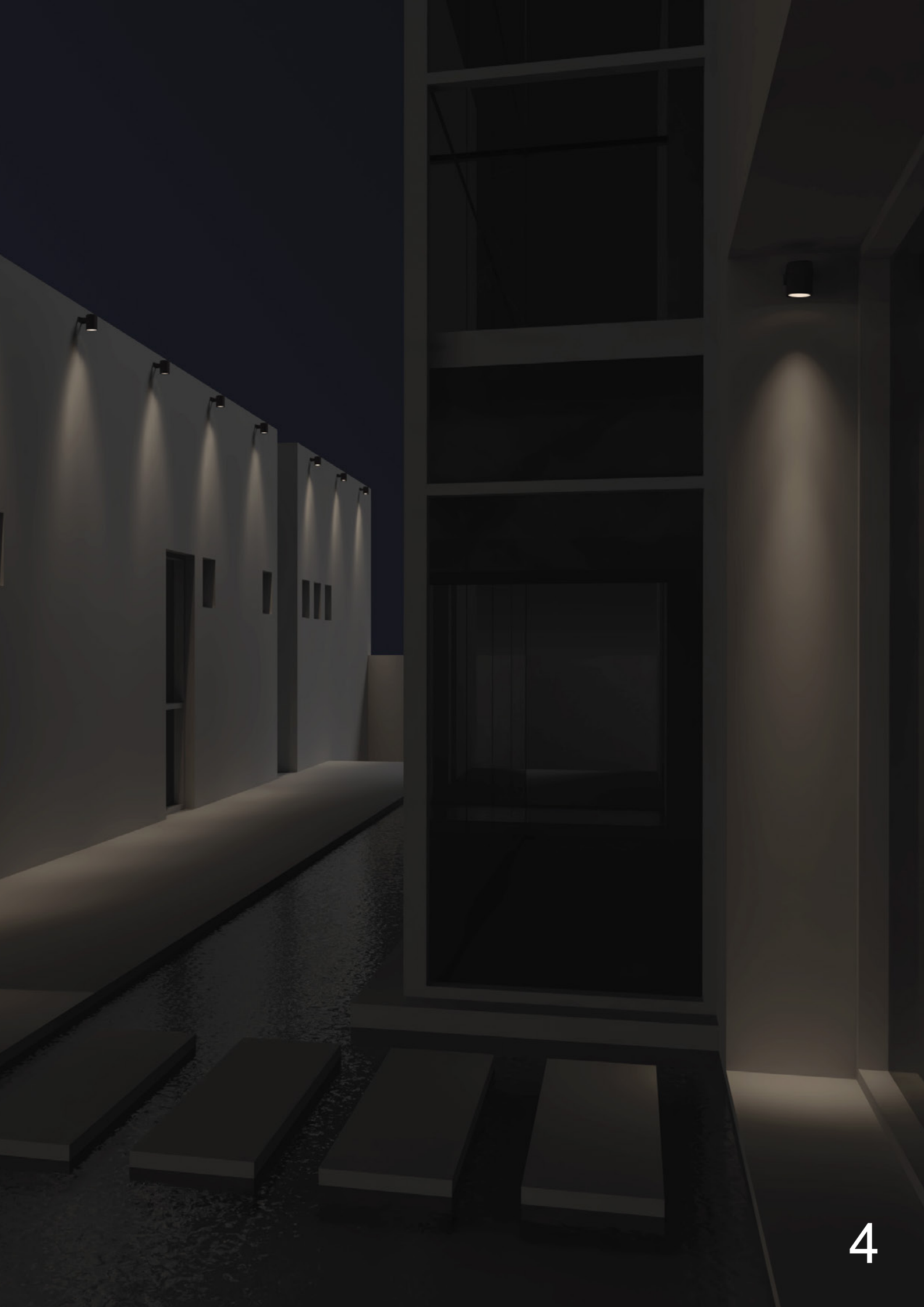

# Flumen

---

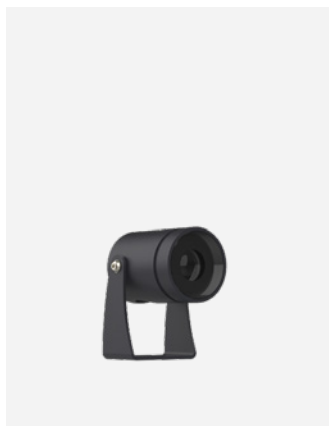

Flumen 1.0

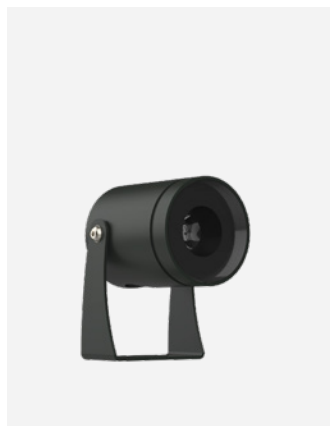

Flumen 2.0

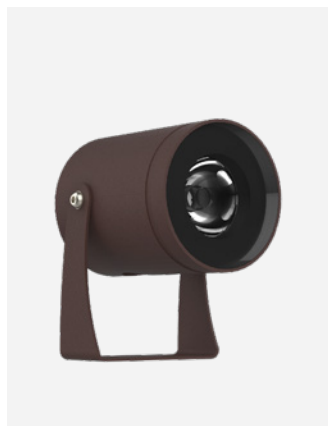

Flumen 3.0



mizar



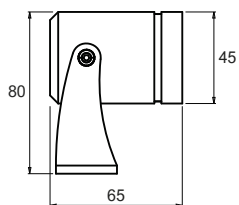

### Flumen 1.0

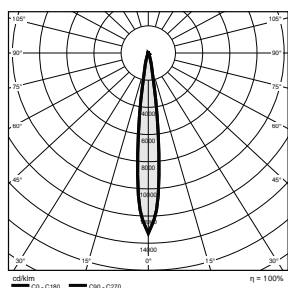

10°

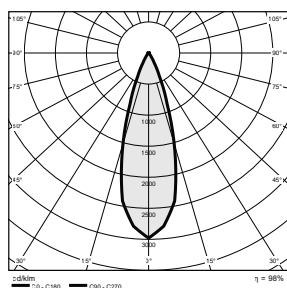

36°

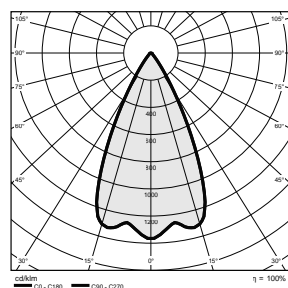

60°

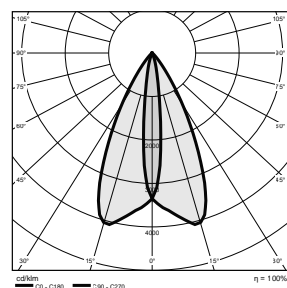

10°x53°

Power	3W
Input Power Supply	24V
Ballast	Remote
Insulation class	III Class
IP rating	IP 66/68
IK rating	IK 10
Body material	Painted anodized aluminum
Finishing colour	Anthracite RAL7016 Corten Dark green RAL6009 White RAL9003
Diffuser material	Tempered extra-clear glass
Operating temperature	-20 / +50°C
CCT	2700K 3000K 4000K
CRI	>90
Lumen output	up to 145 lm
Beam angles	10° 36° 60° 10°x53°
Optical optional	None Honeycomb

# Flumen

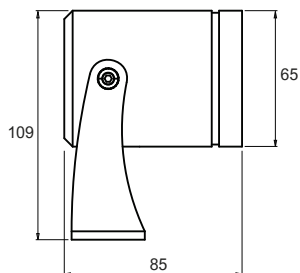

## Flumen 2.0

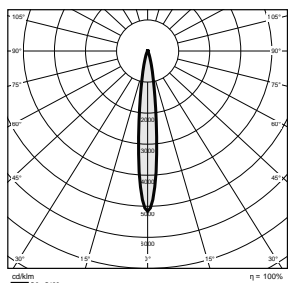

10°

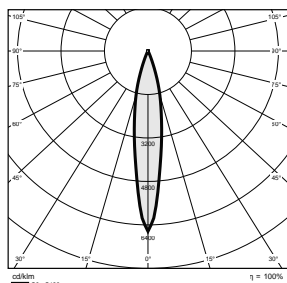

25°

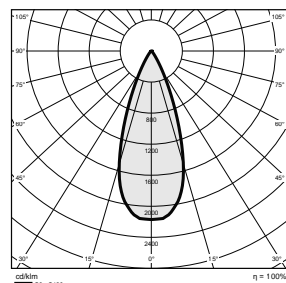

40°

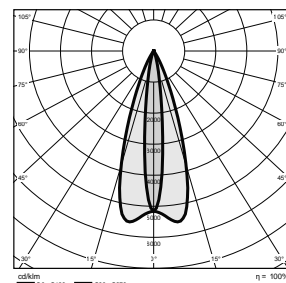

10°x45°

Power	6W
Input Power Supply	24V
Ballast	Remote
Insulation class	III Class
IP rating	IP 66/68

IK rating	IK 10
Body material	Painted anodized aluminum
Finishing colour	Anthracite RAL7016 Corten Dark green RAL6009 White RAL9003
Diffuser material	Tempered extra-clear glass
Operating temperature	-20 / +50°C

CCT	2700K 3000K 4000K
-----	-------------------------

CRI	>90
Lumen output	up to 290 lm
Beam angles	10° 25° 40°

Optical optional	None Honeycomb
------------------	-------------------

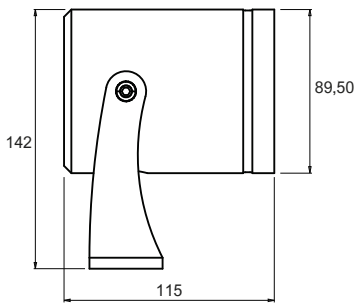

**Flumen 3.0**

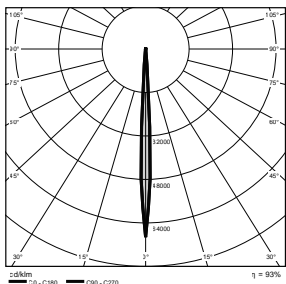

5°

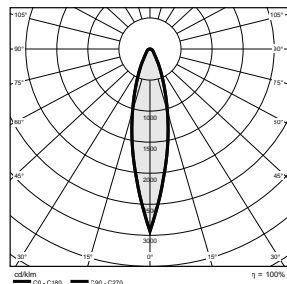

20°

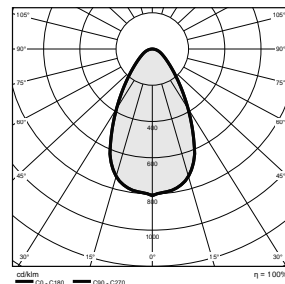

60°

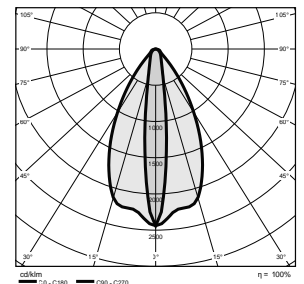

15°x60°

Power	10W
Input Power Supply	24V
Ballast	Remote
Insulation class	III Class
IP rating	IP 66/68
IK rating	IK 10
Body material	Painted anodized aluminum
Finishing colour	Anthracite RAL7016 Corten Dark green RAL6009 White RAL9003
Diffuser material	Tempered extra-clear glass
Operating temperature	-20 / +50°C
CCT	2700K 3000K 4000K
CRI	>90
Lumen output	up to 480 lm
Beam angles	5° 20° 60° 15°x60°
Optical optional	None Honeycomb

# Iris

IRIS, a family of compact spotlights designed to blend seamlessly into nature, letting the lighting effects highlight the textures of leaves and the veins of plant stems. Featuring long stakes, all coated in RAL6009 green, IRIS perfectly integrates into landscapes. With a wide selection of optics and color temperatures, IRIS offers endless possibilities for creating stunning outdoor lighting effects.



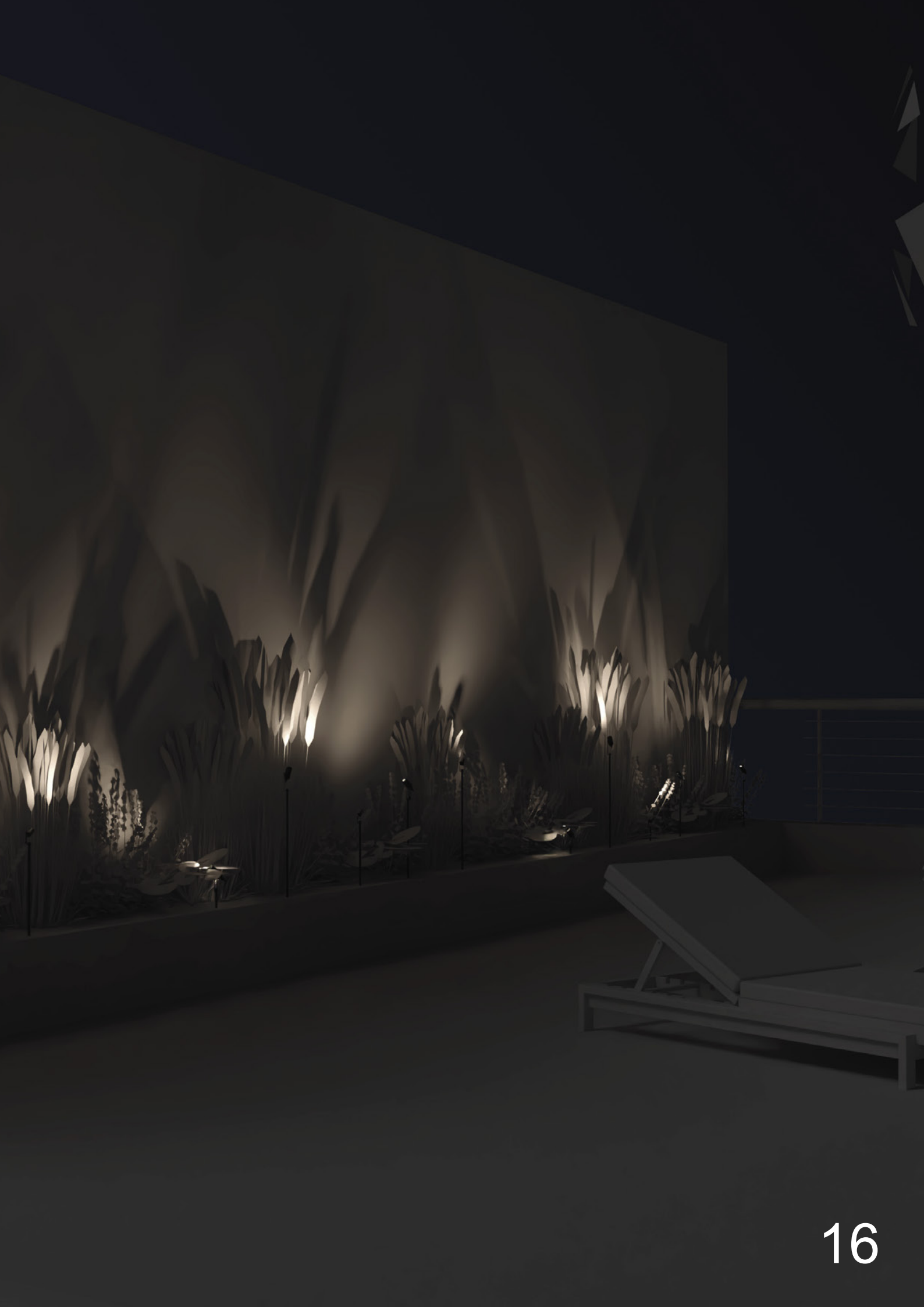

# Iris

---



Iris 1.0



mizar

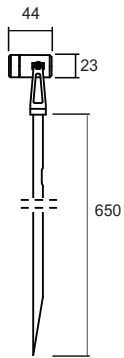

**Iris 1.0**

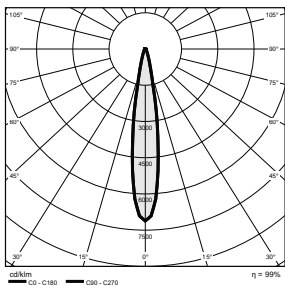

**15°**

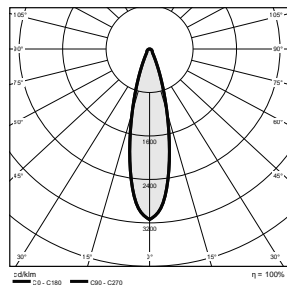

**25°**

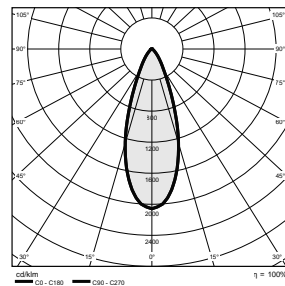

**40°**

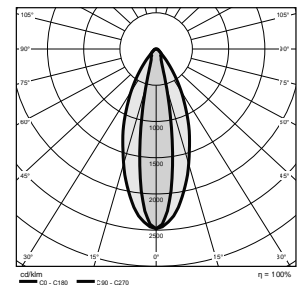

**20°x43°**

Power	1W
Input Power Supply	24V
Ballast	Remote
Insulation class	III Class
IP rating	IP 66/68
IK rating	IK 09
Body material	Painted anodized aluminum
Finishing colour	Dark green RAL6009
Diffuser material	Tempered extra-clear glass
Operating temperature	-20 / +50°C
CCT	2700K
	3000K
	4000K
CRI	>90
Lumen output	up to 53 lm
Beam angles	15°
	25°
	40°
	20°x43°
Optical optional	None

# Iris

---



Iris 2.0



mizar



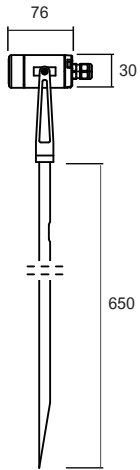

**Iris 2.0**

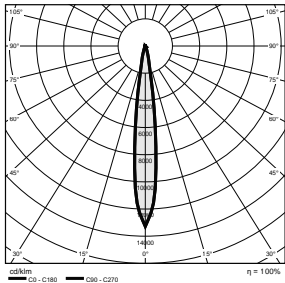

**10°**

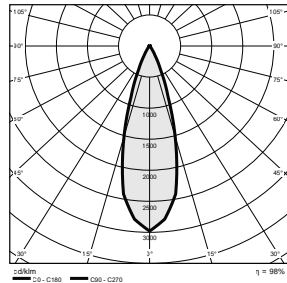

**36°**

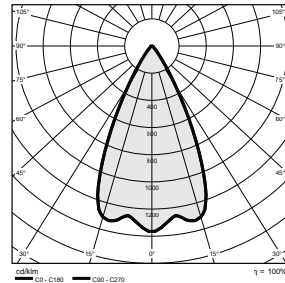

**60°**

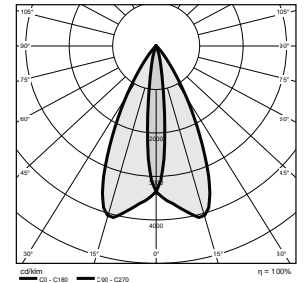

**10°x53°**

Power	2W
Input Power Supply	24V
Ballast	Remote
Insulation class	III Class
IP rating	IP 66/68

IK rating	IK 07
Body material	Painted anodized aluminum
Finishing colour	Dark green RAL6009
Diffuser material	Tempered extra-clear glass
Operating temperature	-20 / +50°C

CCT	2700K
	3000K
	4000K
CRI	>90
Lumen output	up to 96 lm
Beam angles	10°
	36°
	60°
	10°x53°
Optical optional	None
	Honeycomb

# Forma

FORMA, the innovative modular step light designed for ultimate customization. Its LED engine, compatible with standard junction boxes, can be paired with a variety of die-cast shapes. Additionally, the reflector, magnetically attached to the body, offers the freedom to personalize or replace it effortlessly, making FORMA a truly adaptable lighting solution.



# Forma

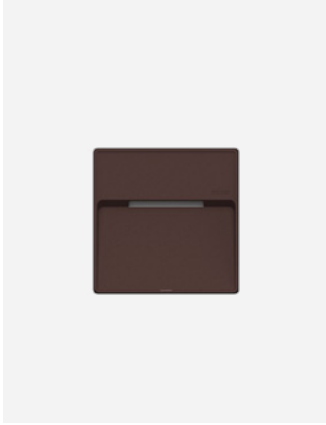

Forma 1.0

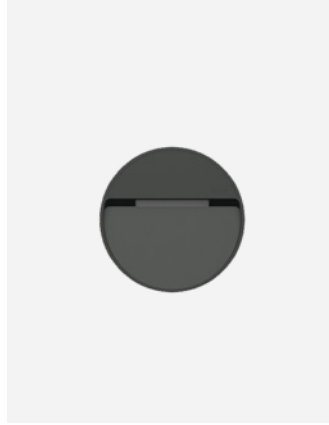

Forma 1.1



Forma 2.0



Forma 2.1

LED engine compatible with standard junction box  
(FORMA 1 with 503 size and FORMA 2 with 506 size)

Modular concept. Square and round shield are  
compatible with the same LED engine.

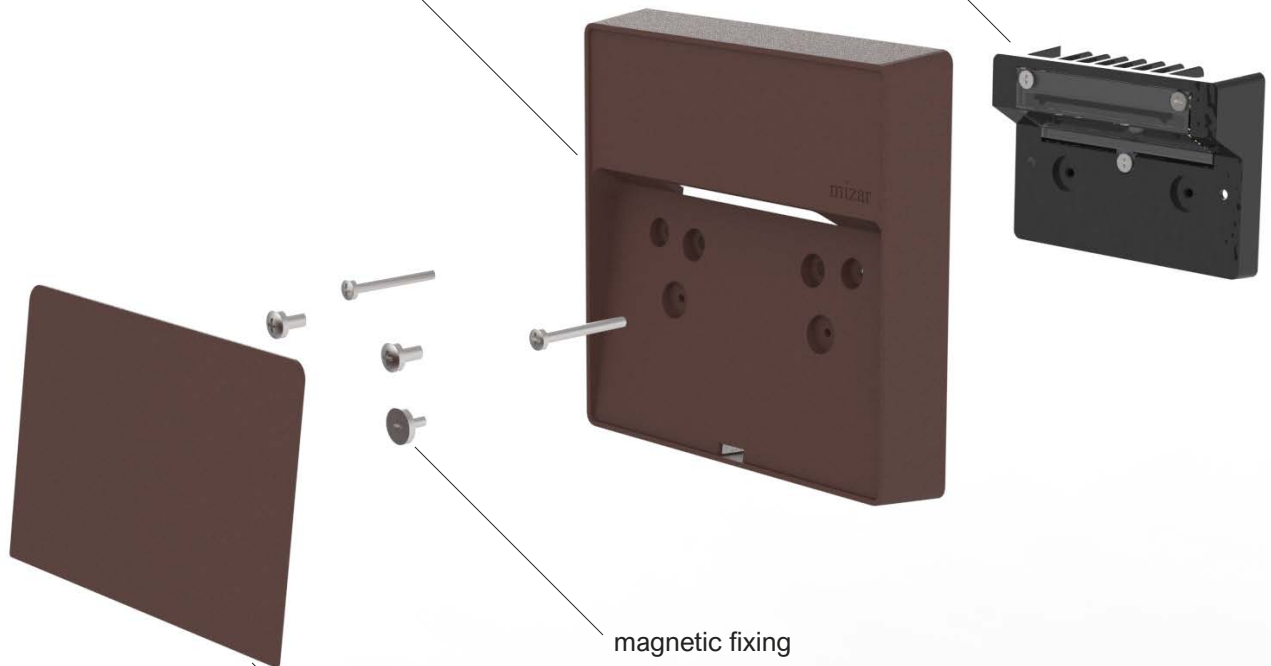

magnetic fixing

reflector is customizable (could be ordered separately)

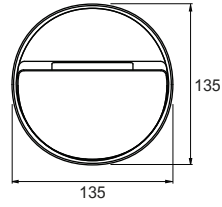
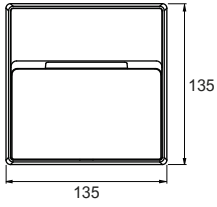

**Forma 1.0**

**Forma 1.1**

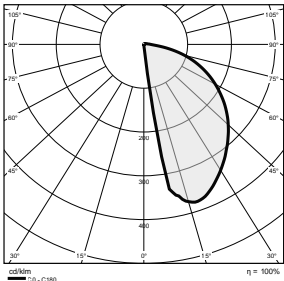

**A20°**

Power	5W
Input Power Supply	24V
Ballast	Remote
Insulation class	III Class
IP rating	IP 66
IK rating	IK 10
Body material	Painted anodized aluminum
Finishing colour	Anthracite RAL7016
	Corten
	Dark green RAL6009
	White RAL9003
Diffuser material	Tempered extra-clear glass
Operating temperature	-20 / +50°C
CCT	2700K
	3000K
	4000K
CRI	>90
Lumen output	up to 275 lm
Beam angles	A20°

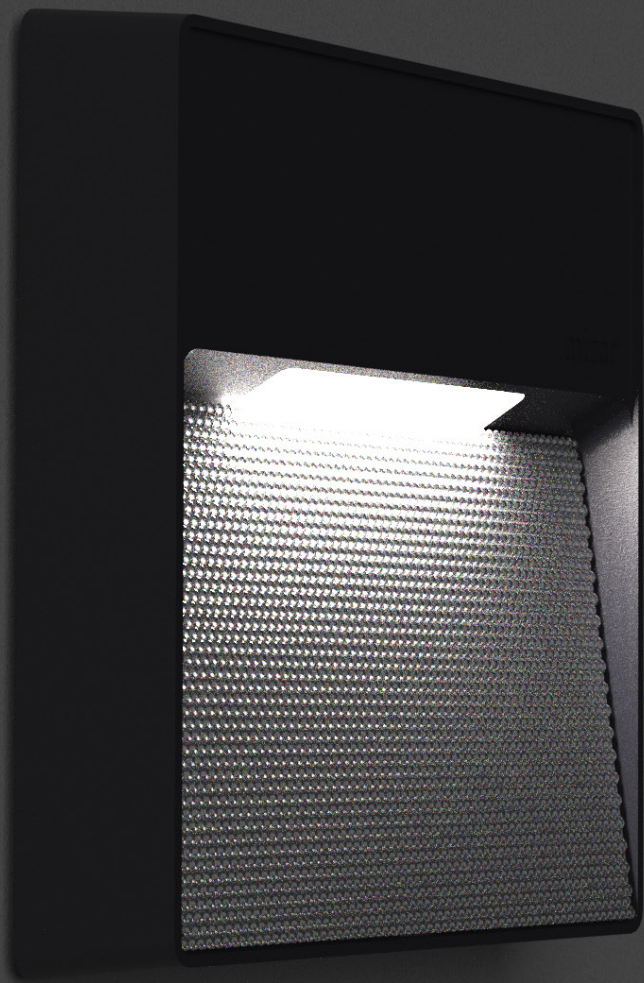

mizar

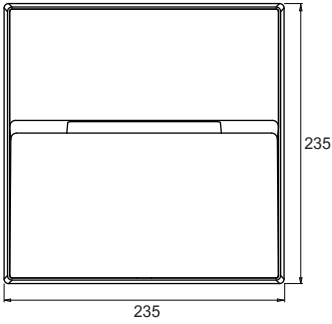

**Forma 2.0**

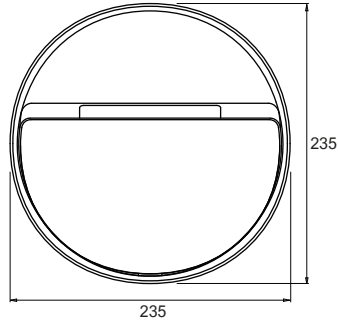

**Forma 2.1**

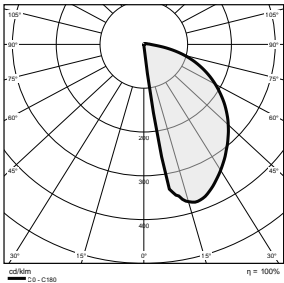

**A20°**

Power	10W
Input Power Supply	24V
Ballast	Remote
Insulation class	III Class
IP rating	IP 66
IK rating	IK 10
Body material	Painted anodized aluminum
Finishing colour	Anthracite RAL7016
	Corten
	Dark green RAL6009
	White RAL9003
Diffuser material	Tempered extra-clear glass
Operating temperature	-20 / +50°C
CCT	2700K
	3000K
	4000K
CRI	>90
Lumen output	up to 550 lm
Beam angles	A20°



# Lucis Bollard

LUCIS BOLLARD, the combination of simplicity and effectiveness. Available in four different heights LUCIS BOLLARD is designed to pleasantly illuminate walkways, gardens, parks and bicycle paths. The body in extruded-aluminium is protected by epoxy-polyester coating that guarantees resistance to corrosion equal to 1500 hours in salt spray.



# Lucis Bollard

---

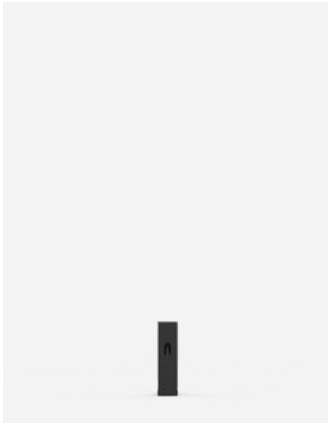

Lucis Bollard 1.0

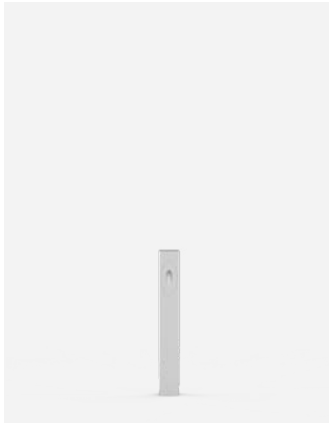

Lucis Bollard 1.1



Lucis Bollard 1.2



Lucis Bollard 1.3

mizar

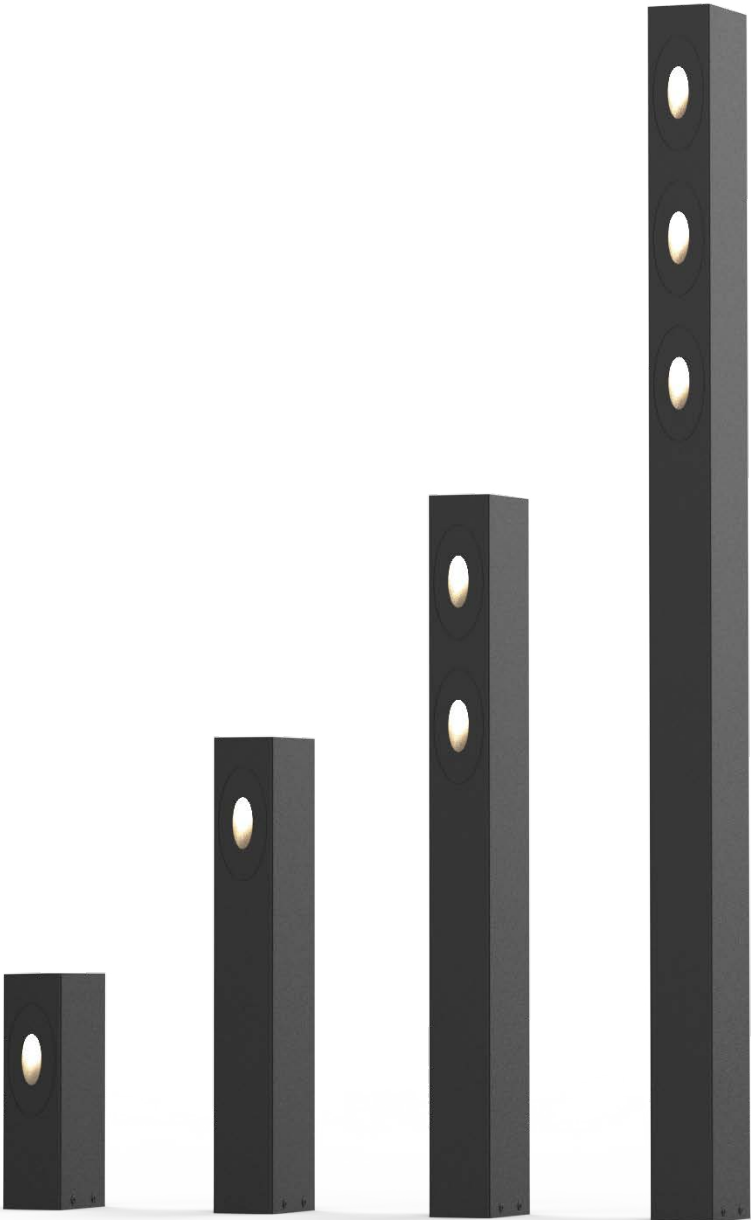

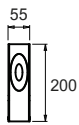

**Lucis Bollard 1.0**

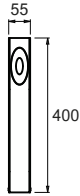

**Lucis Bollard 1.1**

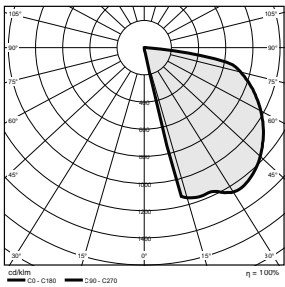

Power	2W
Input Power Supply	220V
Ballast	Integrated
Insulation class	II Class
IP rating	IP 66

IK rating	IK 10
Body material	Painted anodized aluminum
Finishing colour	Anthracite RAL7016
	Corten
	White RAL9003
Diffuser material	Tempered extra-clear glass
Operating temperature	-20 / +50°C

CCT	2700K
	3000K
	4000K
CRI	>90
Lumen output	up to 25 lm
Beam angles	A30°

# Lucis Bollard

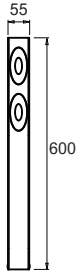

Lucis Bollard 1.2

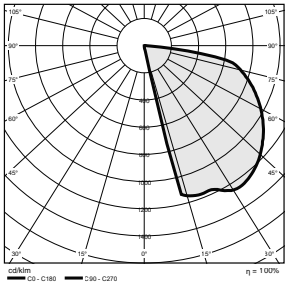

Power	4W
Input Power Supply	220V
Ballast	Integrated
Insulation class	II Class
IP rating	IP 66
IK rating	IK 10
Body material	Painted anodized aluminum
Finishing colour	Anthracite RAL7016 Corten White RAL9003
Diffuser material	Tempered extra-clear glass
Operating temperature	-20 / +50°C
CCT	2700K 3000K 4000K
CRI	>90
Lumen output	up to 50 lm
Beam angles	A30°

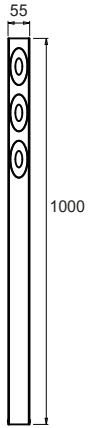

**Lucis Bollard 1.3**

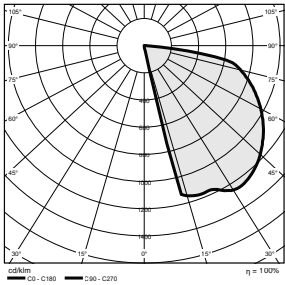

Power	6W
Input Power Supply	220V
Ballast	Integrated
Insulation class	II Class
IP rating	IP 66
IK rating	IK 10
Body material	Painted anodized aluminum
Finishing colour	Anthracite RAL7016 Corten White RAL9003
Diffuser material	Tempered extra-clear glass
Operating temperature	-20 / +50°C
CCT	2700K 3000K 4000K
CRI	>90
Lumen output	up to 75 lm
Beam angles	A30°

# Oceano

OCEANO, the ultimate in-ground lighting solution offering unmatched customization. Available in a wide range of sizes and now presented in 25 stunning new finishes — including bronze, chrome, rose gold, and the exclusive wood-effect resin — OCEANO redefines versatility. With limitless personalization options, it's the perfect choice to bring your creative lighting visions to life.

mizar







# Oceano custom finishings



Matte Glossy

**Copper**



Matte Glossy

**Brushed copper**



Matte Glossy

**Gold**



Matte Glossy

**Brushed gold**



Matte Glossy

**Rose gold**



Matte Glossy

**Brushed rose gold**

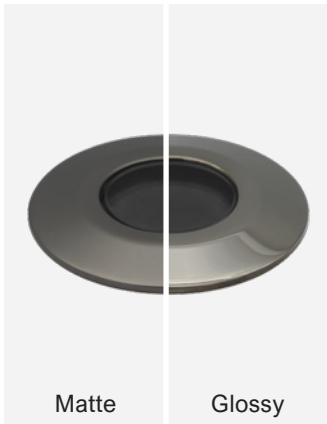

Matte Glossy

**Black chrome**



Matte Glossy

**Brushed black chrome**



Matte Glossy

**Nickel**



Matte Glossy

**Brushed nickel**



Matte Glossy

**Chrome**

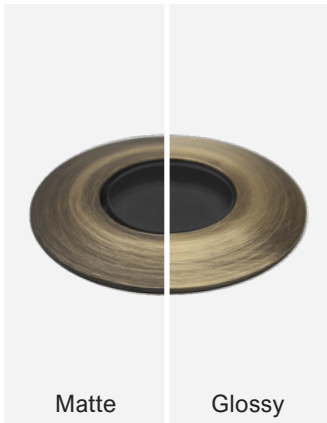

Matte Glossy

**Ancient bronze**



**Technopolymer  
"wood effect"**

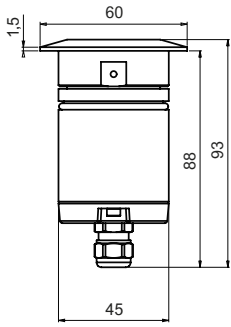

### Oceano 3.0

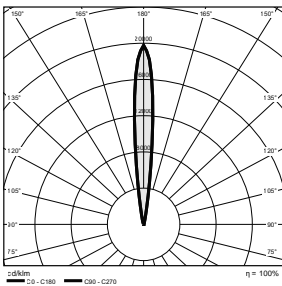

10°

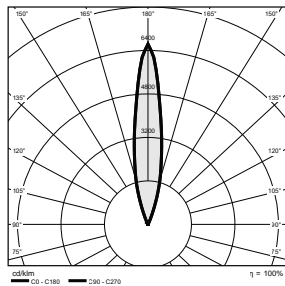

25°

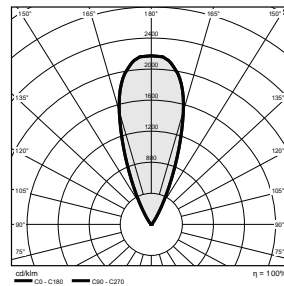

40°

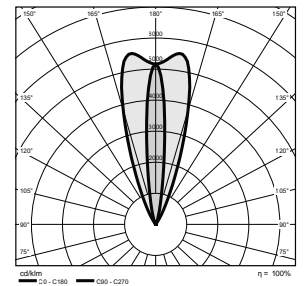

10°x45°

Power  
Input Power Supply  
Ballast  
Insulation class  
IP rating

3W  
24V  
Remote  
III Class  
IP 66/68 (10m)

IK rating  
Body material  
Bazel material

IK 10  
Anodized 20μ aluminum  
Stainless steel 316L  
Anodized 20μ aluminum  
Stainless steel 316L  
Technopolymer

Diffuser material  
Operating temperature  
Maximal static weight

Tempered extra-clear glass  
-20 / +50°C  
500 kg

CCT  
CRI  
Lumen output  
Beam angles

2700K  
3000K  
4000K  
>90  
up to 145 lm  
10°  
25°  
40°  
10°x45°

Optical optional

None  
Honeycomb  
Louvre

# Acus

ACUS, the high-performance recessed luminaire with great mechanical strength, equipped with highly effective optics. The ACUS is the ideal solution for public and architectural lighting, today the ACUS family becomes even wider thanks to the new model with asymmetrical optics and the one with dynamic RGBW lighting.



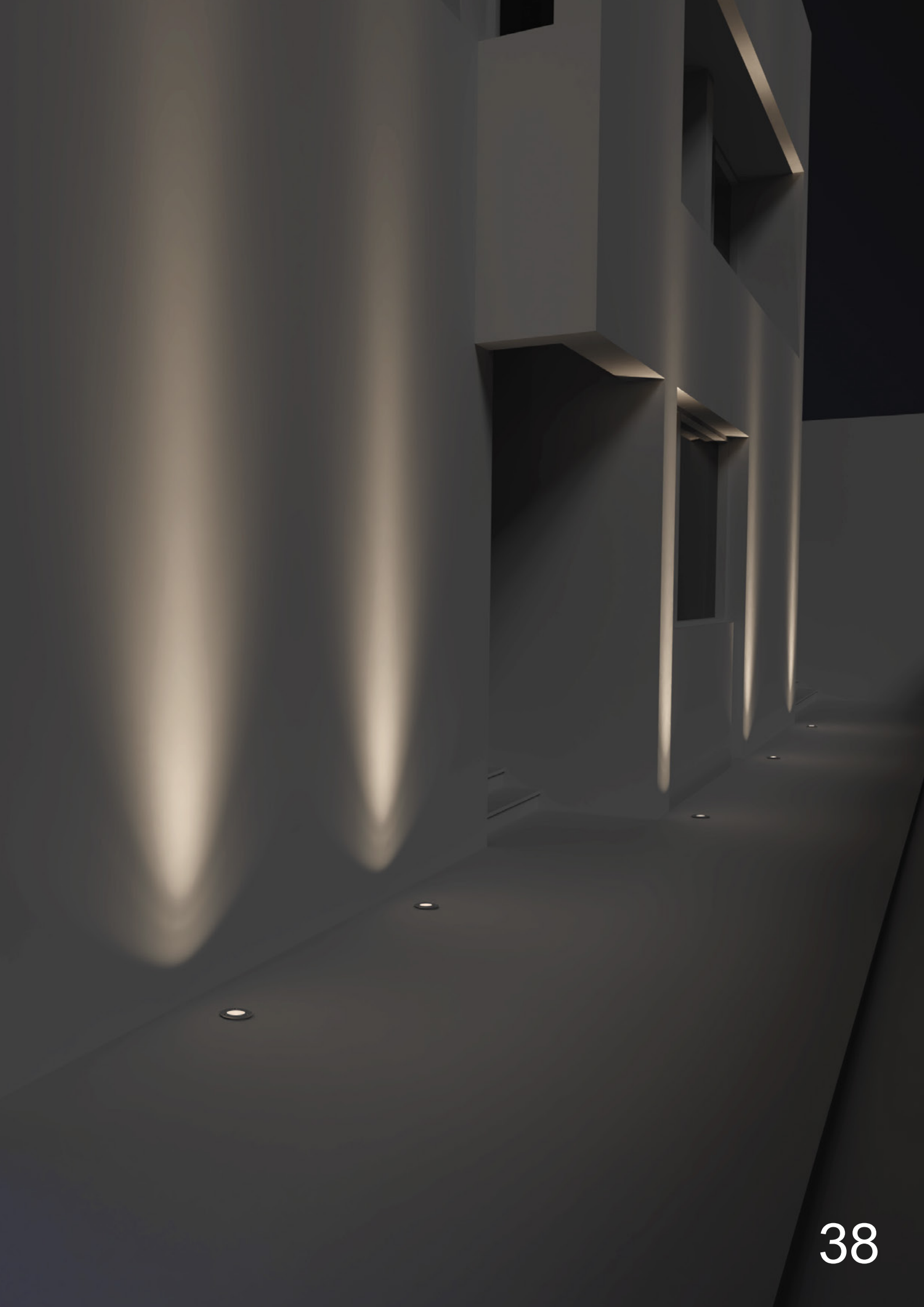

# Acus

---



Acus 1.2



mizar

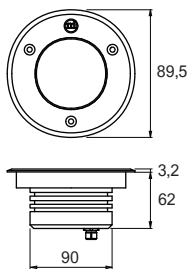

### Acus 1.2

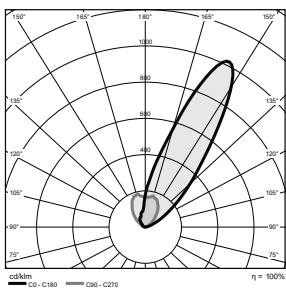

### A30°

Power	13W
Input Power Supply	24V
Ballast	Remote
Insulation class	III Class
IP rating	IP 66/67
IK rating	IK 10
Body material	Anodized 20μ aluminum
Bazel material	Stainless steel 316L
Diffuser material	Tempered extra-clear glass
Operating temperature	-20 / +50°C
Maximal static weight	2000 kg
CCT	2700K 3000K 4000K
CRI	>90
Lumen output	up to 1050 lm
Beam angles	A30°
Optical optional	None Honeycomb



# Acus

---



Acus 1.3 (RGBW)



mizar

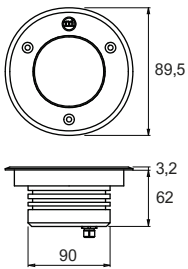

### Acus 1.3

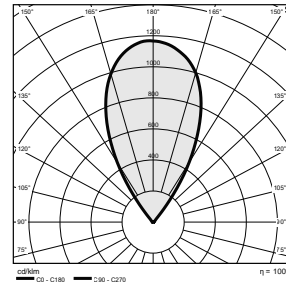
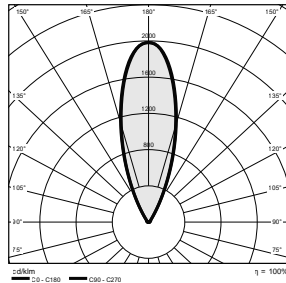
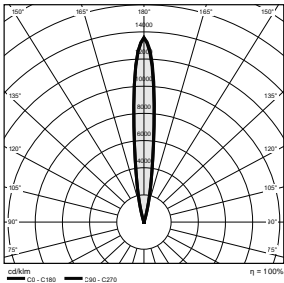

Power	13W
Input Power Supply	24V
Ballast	Remote
Insulation class	III Class
IP rating	IP 66/67

IK rating	IK 10
Body material	Anodized 20μ aluminum
Bazel material	Stainless steel 316L
Diffuser material	Tempered extra-clear glass
Operating temperature	-20 / +50°C
Maximal static weight	2000 kg

CCT	RGBW (4000K)
CRI	>80
Lumen output	up to 850 lm
Beam angles	A30°
Optical optional	None Honeycomb Louvre

# Quantum

QUANTUM, the iconic hour-glass-shaped lighting series, now expanded with exciting new models: ceiling, rigid pendant “tige”, and spotlight. Designed to seamlessly coordinate across complex projects, QUANTUM combines its signature style with a wide selection of color temperatures and optics, ensuring versatility and elegance in every application.



# Quantum

---

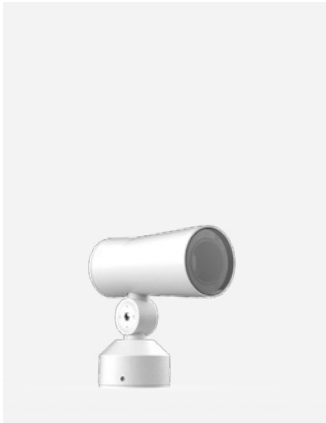

**Quantum Flood 1.0**

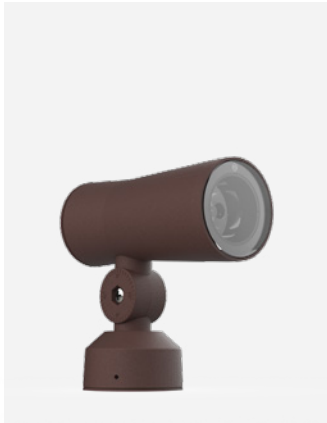

**Quantum Flood 2.0**

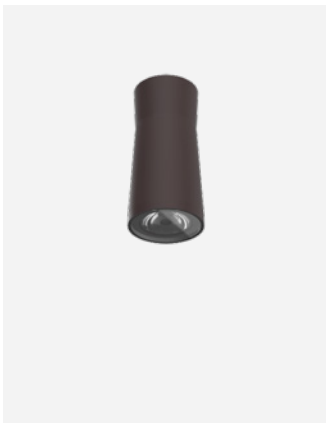

**Quantum Ceiling 1.0**



**Quantum Ceiling 2.0**



**Quantum Tige 1.0**



**Quantum Tige 2.0**



# Quantum Flood

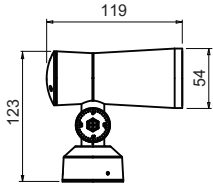

## Quantum Flood 1.0

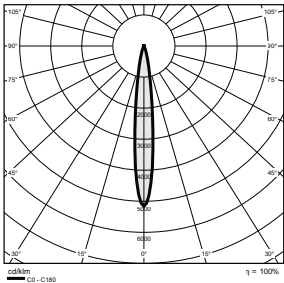

10°

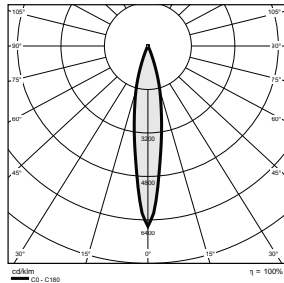

25°

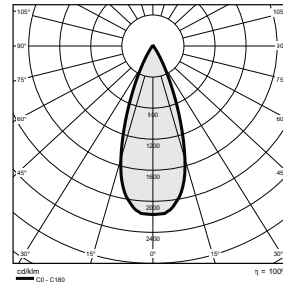

40°

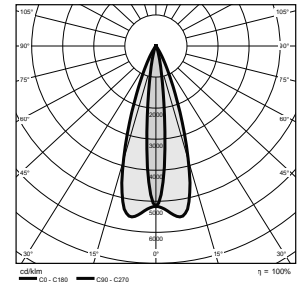

10°x45°

Power  
Input Power Supply  
Ballast  
Insulation class  
IP rating

3W  
220V  
Integrated  
II Class  
IP 66

IK rating  
Body material  
Finishing colour

IK 06  
Painted anodized aluminum  
Anthracite RAL7016  
Black RAL9005  
Corten  
Paintable primer  
White RAL9003

Diffuser material  
Operating temperature

Tempered extra-clear glass  
-20 / +50°C

CCT

2700K  
3000K  
4000K

CRI

>90

Lumen output

up to 145 lm

Beam angles

10°  
25°  
40°  
10°x45°

Optical optional

None  
Honeycomb

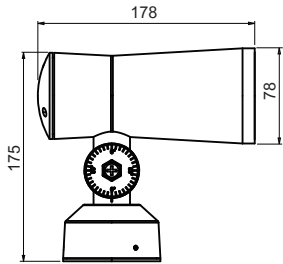

### Quantum Flood 2.0

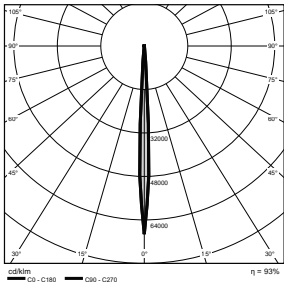

5°

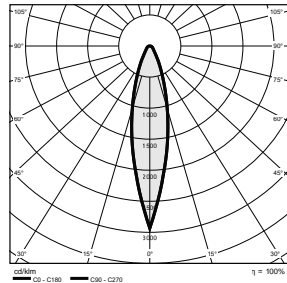

20°

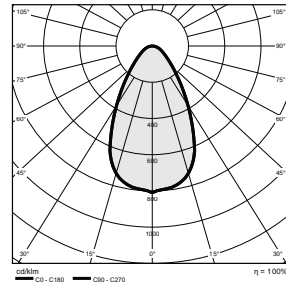

60°

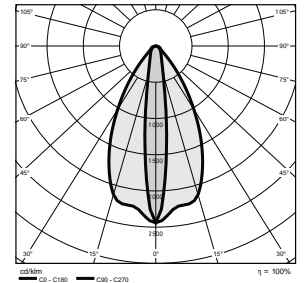

15°x60°

Power	7W
Input Power Supply	220V
Ballast	Integrated
Insulation class	II Class
IP rating	IP 66
IK rating	IK 06
Body material	Painted anodized aluminum
Finishing colour	Anthracite RAL7016 Black RAL9005 Corten Paintable primer White RAL9003
Diffuser material	Tempered extra-clear glass
Operating temperature	-20 / +50°C
CCT	2700K 3000K 4000K
CRI	>90
Lumen output	up to 315 lm
Beam angles	5° 20° 60° 15°x60°
Optical optional	None Honeycomb



# Quantum Ceiling

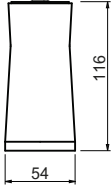

## Quantum Ceiling 1.0

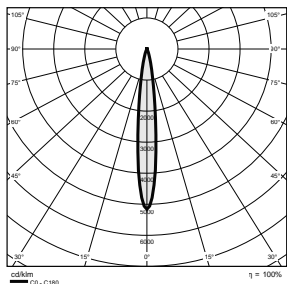

10°

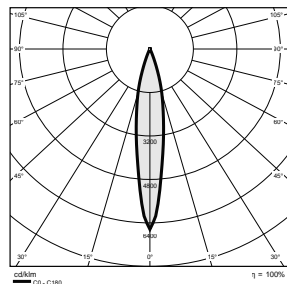

25°

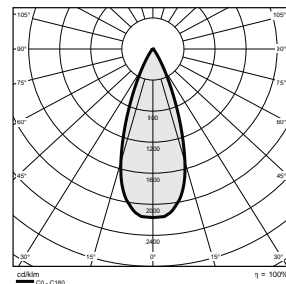

40°

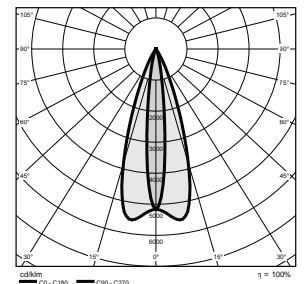

10°x45°

Power	3W
Input Power Supply	220V
Ballast	Integrated
Insulation class	II Class
IP rating	IP 66
IK rating	IK 06
Body material	Painted anodized aluminum
Finishing colour	Anthracite RAL7016 Black RAL9005 Corten Paintable primer White RAL9003
Diffuser material	Tempered extra-clear glass
Operating temperature	-20 / +50°C
CCT	2700K 3000K 4000K
CRI	>90
Lumen output	up to 145 lm
Beam angles	10° 25° 40° 10°x45°
Optical optional	None Honeycomb

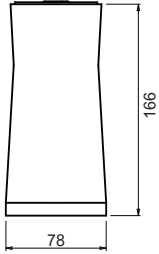
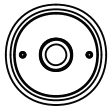

## Quantum Ceiling 2.0

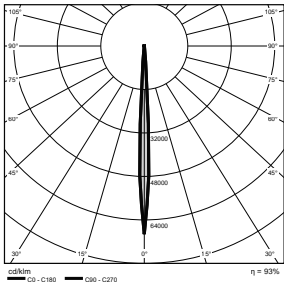

5°

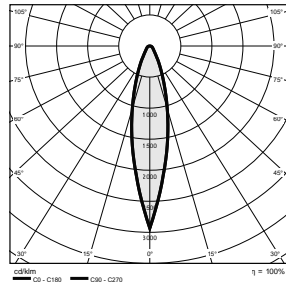

20°

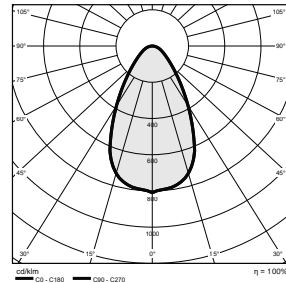

60°

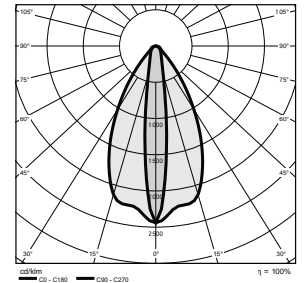

15°x60°

Power  
Input Power Supply  
Ballast  
Insulation class  
IP rating

7W  
220V  
Integrated  
II Class  
IP 66

IK rating  
Body material  
Finishing colour

IK 06  
Painted anodized aluminum  
Anthracite RAL7016  
Black RAL9005  
Corten  
Paintable primer  
White RAL9003

Diffuser material  
Operating temperature

Tempered extra-clear glass  
-20 / +50°C

CCT

2700K  
3000K  
4000K

CRI

>90

Lumen output

up to 315 lm

Beam angles

5°  
20°  
60°  
15°x60°

Optical optional

None  
Honeycomb

# Quantum Tige

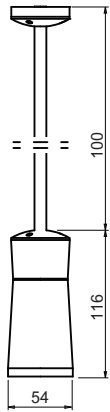

Quantum Tige 1.0

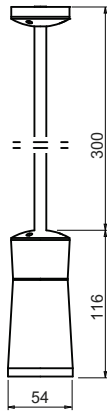

Quantum Tige 1.1

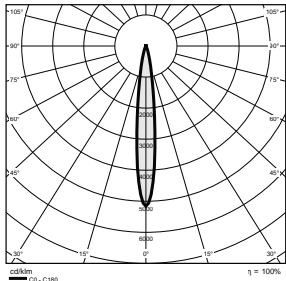

10°

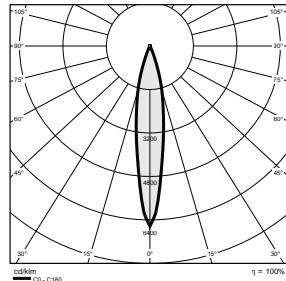

25°

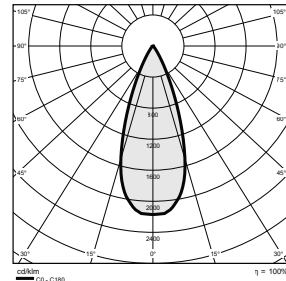

40°

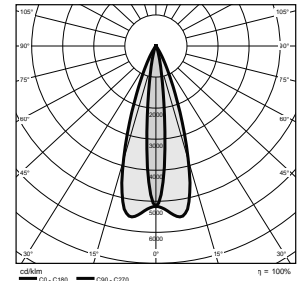

10°x45°

Power	3W
Input Power Supply	220V
Ballast	Integrated
Insulation class	II Class
IP rating	IP 66
IK rating	IK 06
Body material	Painted anodized aluminum
Finishing colour	Anthracite RAL7016 Black RAL9005 Corten Paintable primer White RAL9003
Diffuser material	Tempered extra-clear glass
Operating temperature	-20 / +50°C
CCT	2700K 3000K 4000K
CRI	>90
Lumen output	up to 145 lm
Beam angles	10° 25° 40° 10°x45°
Optical optional	None Honeycomb

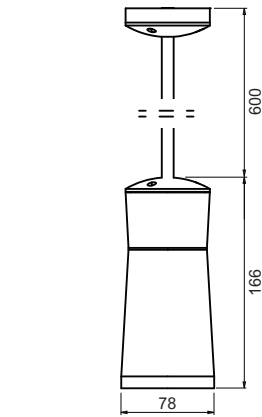
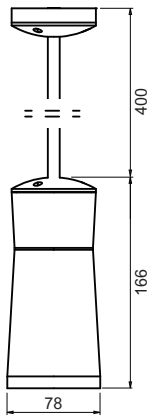

**Quantum Tige 1.0**

**Quantum Tige 2.1**

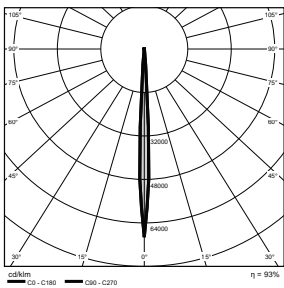

**5°**

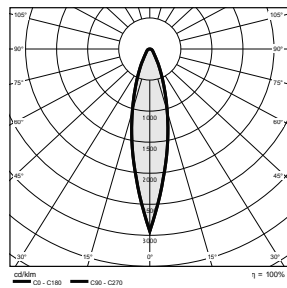

**20°**

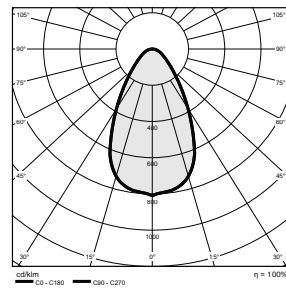

**60°**

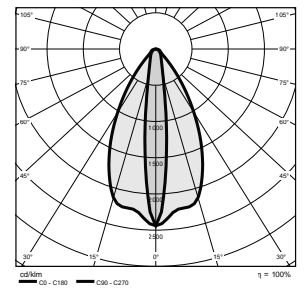

**15°x60°**

Power  
 Input Power Supply  
 Ballast  
 Insulation class  
 IP rating

7W  
 220V  
 Integrated  
 II Class  
 IP 66

IK rating  
 Body material  
 Finishing colour

IK 06  
 Painted anodized aluminum  
 Anthracite RAL7016  
 Black RAL9005  
 Corten  
 Paintable primer  
 White RAL9003

Diffuser material  
 Operating temperature

Tempered extra-clear glass  
 -20 / +50°C

CCT  
 CRI  
 Lumen output  
 Beam angles

2700K  
 3000K  
 4000K  
 >90  
 up to 315 lm  
 5°  
 20°  
 60°  
 15°x60°

Optical optional

None  
 Honeycomb



Mizar  
is a brand of  
ReeR SpA  
Via Carcano 32 10153 Torino  
ITALIA

[mizar.it](http://mizar.it)