



VITRUM 1.0

VITRUM 1.0 36° 2700K
HONEYCOMB-10M

Cod: **VIT01CCM100M00**



IdroSkud® protection system

- polarity reversal protection
- voltage spikes protection
- water infiltration protection



Protection class III

Designed to be supplied from a separated extra-low voltage (SELV) power supply



IP 66

Protected against powerful power jets, 100 liters per minute



IP 68

Protected against continuous immersion up to 3 meters



IK 10

Protected against impact of 20 J



High temperatures

Design to withstand temperatures up to +50° C



Walk-over

Fixture design to withstand a static load up to 5 kN



CX - Extreme

corrosion resistance level ISO 9223



Mizar warranty

5 years warranty



Technical description

Fully flush inground luminaire, walk-over, suitable for outdoor and underwater environments (IP66/IP68) with operating temperature range: -20°C / +50°C. Its special feature is that it has a tempered glass screen without metal frame, transparent, with black screen-printed edge. The body is made of black anodized anticorrosive aluminum. The light source consists of a single 2W power Led chip powered at 24Vdc constant voltage with integrated driver. The minimalist design makes it ideal as a lighting fixture for elegant indoor and outdoor environments, as well as for high-humidity situations (spas, wine cellars). The source is set back for greater visual comfort. Color rendering index CRI > 90. Vitrum is equipped with IdroSkud® system to protect electronic components from voltage spikes, polarity reversal and water infiltration. There are optional accessories for anti-glare (honeycomb) and installation accessories (draining, watertight and plasterboard outercase).

Lighting data

Source type	single chip power LED	Photobiological risk	RG0
CCT	2700K	ULR	100.00%
CRI	> 90	BUG Rating	B0 U1 G0
MacAdam (SDCM)	2	CIE Flux Code	0 0 0 0 100
Source lumen output (lm)	157	LED lifetime	L80 B10 50.000h
Luminaire lumen output (lm)	90	Efficiency class	This product contains a light source of energy efficiency class (EU2019/2015): F
Light emission	Medium		
Beam angle	36°		

Mechanical data

Diameter (mm)	40	Class ISO 9223	CX
Height (mm)	77	Optic type	Technopolymer TIR Lens
Weight (g)	113	Optical optional	Honeycomb
IP Rating	IP66 / IP68	Maximal working temperature	+50° C
IK rating	IK10	Minimal working temperature	-20° C
Finishing colour	Black silk-screen	Maximal static load (kN)	5
Body material	Anodized aluminum anticorodal 6082	Walk-over	Yes
External screws material	Stainless steel 316L (A4)	Driver-over	No
Diffuser material	Extraclear tempered glass	Maximal surface temperature	+50° C
Diffuser thickness (mm)	8	Areas EN 60598-2-13	A1 / A2

Electrical data

Nominal power (W)	2	Electrical connection	Parallel connection
Power supply (input power type)	Costant voltage - 24V	Idroskud® protection	Yes
Ballast	Remote	Inverse polarity protection	Yes
Insulation class	III	Voltage spikes protection	Yes
Dimmable	Yes		
Power cable type	H05RN - F 2x0,75 mm ²		
Power cable length	10 m (verify voltage drop), 10 m (verify voltage drop)		

Photometry

36°



Technical drawing

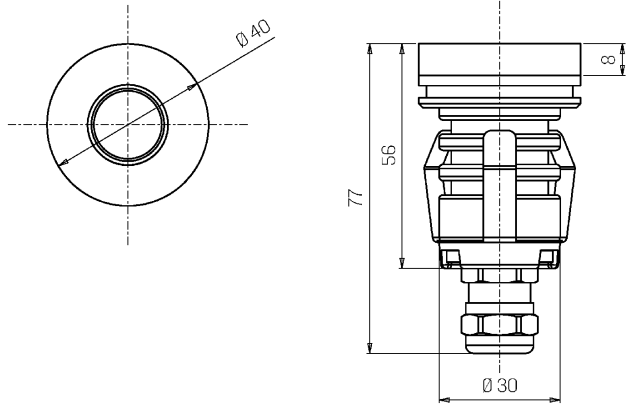

Accessories



NOT DIMMABLE POWER SUPPLY

Power supply 220/240 50/60Hz ON/OFF
24V 14,4W IP67

Cod: MID0019



NOT DIMMABLE POWER SUPPLY

Power supply 220/240 50/60Hz ON/OFF
24V 36W IP67

Cod: MID0020



DIMMABLE POWER SUPPLY

Power supply 220/240 50/60Hz ON/OFF
24V 24W IP67 DALI

Cod: MID0021



DRAINING OUTERCASE

Outercase draining VITRUM 1

Cod: VITZZZ000



SLIM DRAINING OUTERCASE

Outercase slim VITRUM 1

Cod: VITZZZ003



PLASTERBOARD RING

Plasterboard ring VITRUM 1

Cod: VITZZZ006



EXTRACTION KIT

Suction cup for VITRUM 1

Cod: VITZZZ009