

# LINEO 1.2

LINEO 1.2 1510mm OPAL 3000K

Cod: **LNE02DBK000A00**

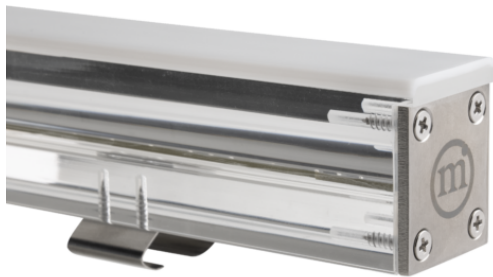

#### IdroSkud® protection system

- polarity reversal protection
- voltage spikes protection
- water infiltration protection



#### Protection class III

Designed to be supplied from a separated extra-low voltage (SELV) power supply



#### IP 66

Protected against powerful power jets, 100 liters per minute



#### IP 67

Protected against temporary immersion (30 minutes) up to 1 meter



#### IK 10

Protected against impact of 20 J



#### High temperatures

Design to withstand temperatures up to +50° C



#### Driver-over

Fixture design to withstand a static load up to 20 kN



#### CX - Extreme

corrosion resistance level ISO 9223



#### Mizar warranty

5 years warranty



## Technical description

Linear in-ground luminaire, drive-over, suitable for outdoor environments (IP66/IP67), with operating temperature range: -20°C / +50°C. The body is made of PMMA, transparent and opal on the upper side; the endcaps are made of 316L stainless steel. The light source is LED SMD3014, powered at 24V with built-in driver. The luminous flux makes it ideal for marking pedestrian and driveway paths, or creating light cuts on floors, walls and ceilings. Color rendering index CRI > 80. Lineo is equipped with IdroSkud® system to protect electronic components from voltage spikes, polarity reversal and water infiltration. Installation accessories are provided (floor and plasterboard outercase; cable extensions up to 15 m).

### Lighting data

Source type	SMD chip 3014	Photobiological risk	RG0
CCT	3000K	ULR	100.00%
CRI	> 80	BUG Rating	B0 U1 G0
MacAdam (SDCM)	3	CIE Flux Code	0 0 0 0 100
Source lumen output (lm)	1980	LED lifetime	L80 B10 50.000h
Luminaire lumen output (lm)	452	Efficiency class	This product contains a light source of energy efficiency class (EU2019/2015): F
Light emission	Diffused		
Beam angle	120°		

### Mechanical data

Width (mm)	27	Diffuser material	Opal PMMA
Length (mm)	1510	Class ISO 9223	CX
Height (mm)	49	Optical optional	None
Weight (g)	1470	Maximal working temperature	+50° C
IP Rating	IP66 / IP67	Minimal working temperature	-20° C
IK rating	IK10	Maximal static load (kN)	20
Finishing colour	Opal white	Walk-over	Yes
Frame material	Stainless steel 316L	Driver-over	Yes
Body material	Trasparent PMMA	Maximal surface temperature	+50° C
External screws material	Stainless steel 316L (A4)	Areas EN 60598-2-13	A1 / A2 / A3 / A4

### Electrical data

Nominal power (W)	18	Electrical connection	Parallel connection
Power supply (input power type)	Costant voltage - 24V	Idroskud® protection	Yes
Ballast	Remote	Inverse polarity protection	Yes
Insulation class	III	Voltage spikes protection	Yes
Dimmable	Yes		
Connector type	M12 - 5 poles IP67		
Power cable length	0,4 m		

Photometry

Technical drawing

Diffused

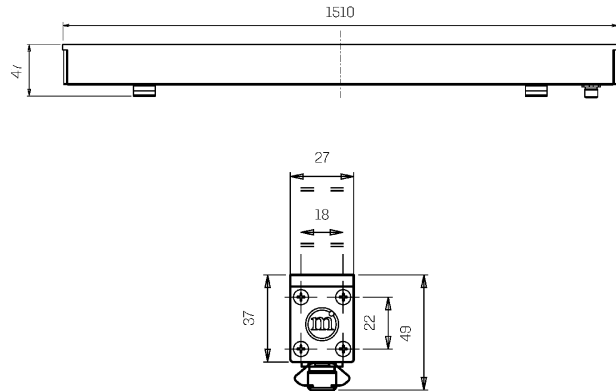
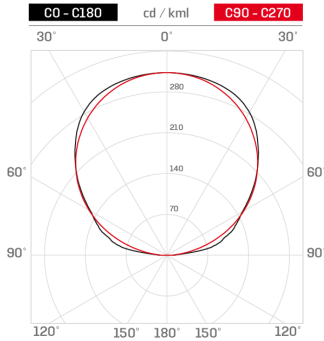

Accessories



**FLOOR OUTERCASE 1511 MM**

Outercase PC for floor 1511mm LINEO

Cod: LNEZZZ002



**PLASTER OUTERCASE 1511 MM**

Outercase PC for plasterboard 1511mm LINEO

Cod: LNEZZZ005



**EXTENSION 0,5 M**

5-pole extension 0.5m OT/NI rings for LINEO

Cod: LNEZZZ012



**EXTENSION 1 M**

5-pole extension 1m OT/NI rings for LINEO

Cod: LNEZZZ013



**EXTENSION 1,5 M**

5-pole extension 1.5m OT/NI rings for LINEO

Cod: LNEZZZ014



**EXTENSION 5 M**

5-pole extension 5m OT/NI rings for LINEO

Cod: LNEZZZ015



**EXTENSION 10 M**

5-pole extension 10m OT/NI rings for LINEO

Cod: LNEZZZ016



**EXTENSION 15 M**

5-pole extension 15m OT/NI rings for LINEO

Cod: LNEZZZ017

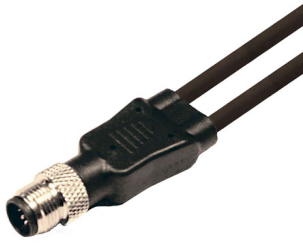

**SPLITTER 2 WAY**

2-way 5-pole splitter with OT/NI rings for LINEO

Cod: LNEZZZ019

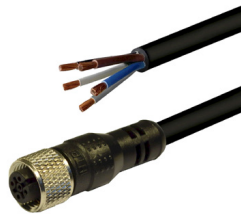

**POWER CABLE**

Power cable 5 poles - M12 female 1,5m

Cod: LNEZZZ021

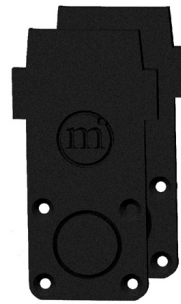

**OUTERCASE HEAD KIT**

Head kit for ground LINEO outercase

Cod: LNEZZZ022

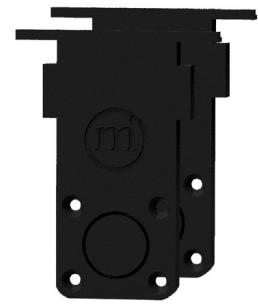

**PLASTER OUTERCASE HEAD KIT**

Head kit for plasterboard LINEO outercase

Cod: LNEZZZ023



**OUTERCASE FIXING KIT**

Fixing kit for LINEO outercase

Cod: LNEZZZ024



**OUTERCASE COUPLING KIT**

Bracket kit for coupling LINEO outercase

Cod: LNEZZZ025



**EXTRACTION KIT**

Extraction kit from outercase for LINEO

Cod: LNEZZZ026



**NOT DIMMABLE POWER SUPPLY**

Power supply DC 24V 150W 6,25A IP67

Cod: MID0029



**DIMMABLE POWER SUPPLY**

Power supply DC 24V 120W 5A IP67  
DALI2/PWM

Cod: MID0030



**DIMMABLE POWER SUPPLY**

Power supply DC 24V 200W 5A IP67  
DALI2/PWM

Cod: MID0031