

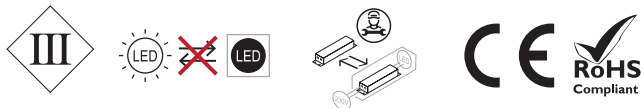

power	13W - Led C.O.B.
power supply	700mA Costant Current Integrated driver
Insulation class	III class
IP rating	IP66 / IP67
IK rating	IK 10
operating temperature	-20°C / +50°C
size	Ø 140 x 106 mm
light source flux	1313 lm (3000K)
effective flux	980 lm (3000K)
optics	adjustable ±8° with TIR lens
beam angle	15° - 26° - 60°
CCT	2700K - 3000K - 4000K
CRI	CRI 90
BIN selection	3 Step MacAdam
body	anticorodal aluminium 6082 anodised black 20µ
frame	aisi 316L electropolished shot peened stainless steel
screen	tempered extra-clear glass 12 mm thick
installation	with formwork
power cable	connetion via quick connector suppliede
electrical connection	series connection
weight	1650 g
protection system	IdroSkud® System _ polarity reversal protection _ voltage peak protection _ water ingress protection

This product contain an energy class **F** light source.



DISPOSAL OF MATERIALS

Dispose of the product in an eco-compatible manner and in accordance whit national legislation



For Countries in the European Union:

Pursuant to the Directive no. 2012/19/EU on waste electrical and electronic equipment (WEEE).

The crossed out wheelie-bin symbol on the equipment or its packaging means that when the product reaches the end of its usefull life it must be collected separately from other waste.

Proper separate collection of the discarded equipment for the later enviromental-friendly recycling, processing and disposal, helps to avoid any negative impact on the enviroment and health and encourages re-use and recycling of the materials the equipment is made of.

In each individual Member State of the European Union this product is required to be disposed of in accordance with Directive **2012/19/EU** as implemented in the Member State where the product is disposed of.

For futher information please contact REER or your local dealer.

The precise and complete observance of all rules, indications and prohibitions set out in these instructions is an essential requirement for the correct operation and use of the product. Mizar, therefore, declines all responsibility for anything deriving from the non-observance, even partial, of these instructions.

Specifications subject to change without notice.
Total or partial reproduction is prohibited without Mizar permission.



8543341

mizar

MADE IN ITALY



ACUS 2.0

DRIVE OVER RECESSED SPOTLIGHT

OPERATING AND INSTALLATION INSTRUCTIONS

8543341_0

MIZAR is a REER S.p.A. brand
via Carcano 32 | 10153 Turin | ITALY
Ph. +39 011 9969833
e-mail: aftersales@mizar.it | www.mizar.it



WARNING

- ⚠ Read the following instructions carefully and keep them.
- ⚠ Technical product data can be found on the back of the sheet and on the product label.
- ⚠ Always switch off the power supply before installation or maintenance.
- ⚠ The device must be installed by qualified personnel. MIZAR accepts no liability if installation is not carried out in accordance with current standard.
- ⚠ Modifications or tampering with the product, not authorized by MIZAR, void all warranty conditions.
- ⚠ Product for indoor and outdoor use.
- ⚠ Never cover visible parts of the product.
- ⚠ No metal parts must be in direct contact or come into contact with aggressive chemicals (fertilisers, aggressive detergents)
- ⚠ Do not stare at the light source during its operation.
- ⚠ Clean the device periodically, avoiding dirt accumulation (at least twice a year).
- ⚠ Please contact MIZAR for Led replacement.
- ⚠ If the glass breaks, the product cannot be used; contact Mizar for replacement.

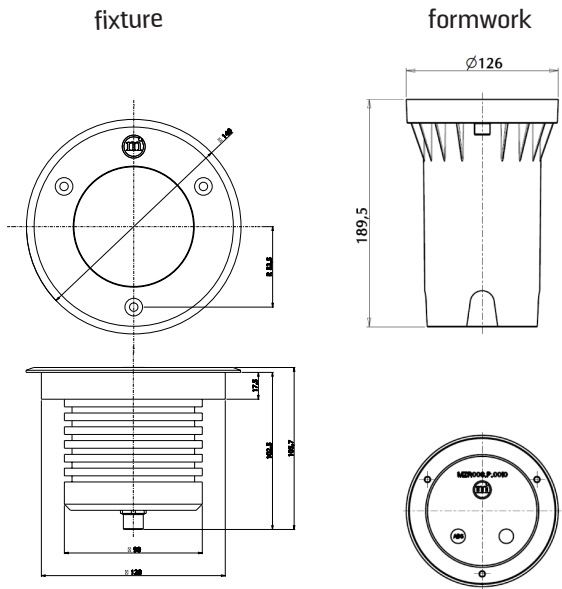

ASSEMBLY INSTRUCTIONS

1 Use the windows at the base of the formwork for the passage of corrugated pipes. Use a drill bit to insert Pg9 cable glands in order to seal the hole.

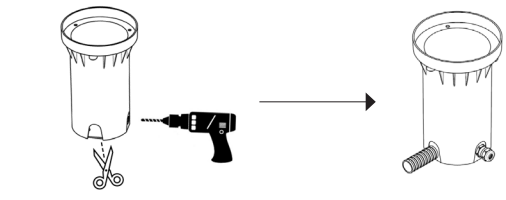

2 Arrange the formwork housing so that the upper edge is perfectly coplanar to the floor level.

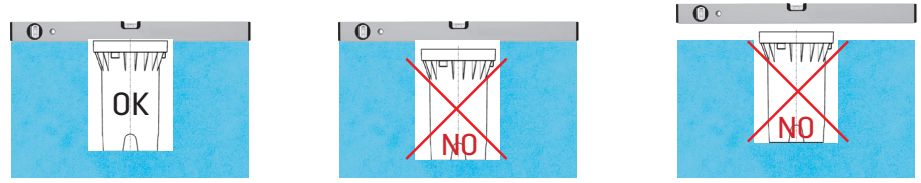

3 Use the holes in the formwork to align them evenly with the reference wall so that all units are oriented in the same way.

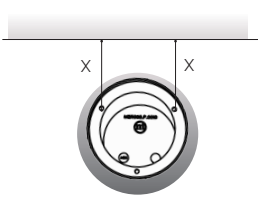

4 create a drainage suitable for draining of moisture that may be created inside the formwork.

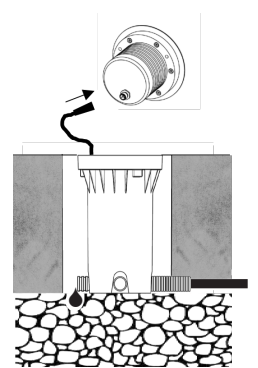

5 After the electrical connection has been made, secure the unit to the formwork using the screws provided.

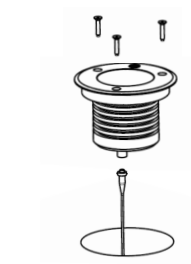

Optical adjustment orientation $\pm 8^\circ$

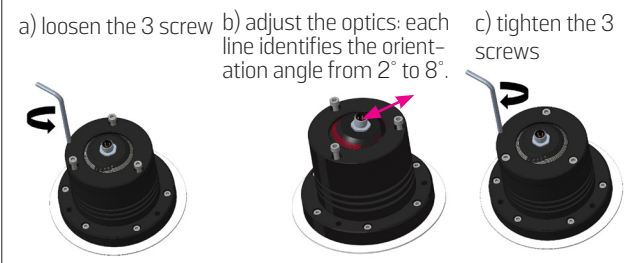

Series connection instructions

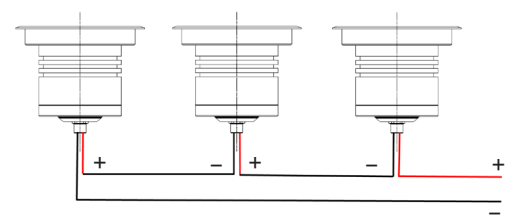

A female connector is included in the package. Carry out the wiring as shown in the illustration.

