

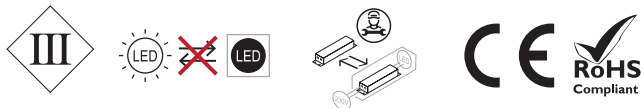

power	2 W – single chip Power Led
power supply	24V Costant Voltage driver integrated
insulation class	III Class
IP rating	IP66 / IP68 10 m
IK rating	IK 07
operating temperature	-20°C / +50°C
size	Ø 40x76 mm / 40x40x76 mm
light source flux	195 lm (3000K)
effective flux	120 lm (3000K)
beam angles	10° - 36° - 60° - elliptical 10° x 53°
CCT	2700K - 3000K - 4000K
CRI	> 90
BIN selection	2 Step MacAdam
body material	_ anticorodal 6082 aluminium anodized 20µ _ 316L stainless steel
frame material	_ anticorodal 6082 aluminium anodized 20µ _ 316L stainless steel _ brass
screen	extra clear tempered glass sp. 6 mm
installation	_ formwork _ plasterboard spring
power cable	H05RN - F 2X0.75 mm²
electrical connection	parallel connection
weight	102 g (alluminium) - 222 g (steel)
protection system	IdroSkud® System _ polarity reversal protection _ voltage spikes protection _ water ingress protection

This product contain an energy class **F** light source.



DISPOSAL OF MATERIALS

Dispose of the product in an eco-compatible manner and in accordance whit national legislation



For Countries in the European Union:
Pursuant to the Directive no. 2012/19/EU on waste electrical and electronic equipment (WEEE).

The crossed out wheelie-bin symbol on the equipment or its packaging means that when the product reaches the end of its usefull life it must be collected separately from other waste. Proper separate collection of the discarded equipment for the later enviromental-friendly recycling, processing and disposal, helps to avoid any negative impact on the environment and health and encourages re-use and recycling of the materials the equipment is made of.

In each individual Member State of the European Union this product is required to be disposed of in accordance with Directive **2012/19/EU** as implemented in the Member State where the product is disposed of.

For futher information please contact REER or your local dealer.

The precise and complete observance of all rules, indications and prohibitions set out in these instructions is an essential requirement for the correct operation and use of the product. Mizar, therefore, declines all responsibility for anything deriving from the non-observance, even partial, of these instructions.

Specifications subject to change without notice.
Total or partial reproduction is prohibited without Mizar permission.



8543320

mizar

MADE IN ITALY



OCEANO 2.0 - 2.1

RECESSED SPOTLIGHT

OPERATING AND INSTALLATION INSTRUCTIONS

8543320_0

MIZAR is a REER S.p.A. brand
via Carcano 32 | 10153 Turin | ITALY
Ph. +39 011 9969833
e-mail: aftersales@mizar.it | www.mizar.it



WARNING

- ⚠ Read the following instructions carefully and keep them.
- ⚠ Technical product data can be found on the back of the sheet and on the product label.
- ⚠ Always switch off the power supply before installation or maintenance.
- ⚠ The device must be installed by qualified personnel. MIZAR accepts no liability if installation is not carried out in accordance with current standard.
- ⚠ Modifications or tampering with the product, not authorized by MIZAR, void all warranty conditions.
- ⚠ Product for indoor and outdoor use.
- ⚠ Never cover visible parts of the product.
- ⚠ No metal parts must be in direct contact or come into contact with aggressive chemicals (fertilisers, aggressive detergents)
- ⚠ Do not stare at the light source during its operation.
- ⚠ Clean the device periodically, avoiding dirt accumulation (at least twice a year).
- ⚠ Please contact MIZAR for Led replacement.
- ⚠ If the glass breaks, the product cannot be used; contact Mizar for replacement.

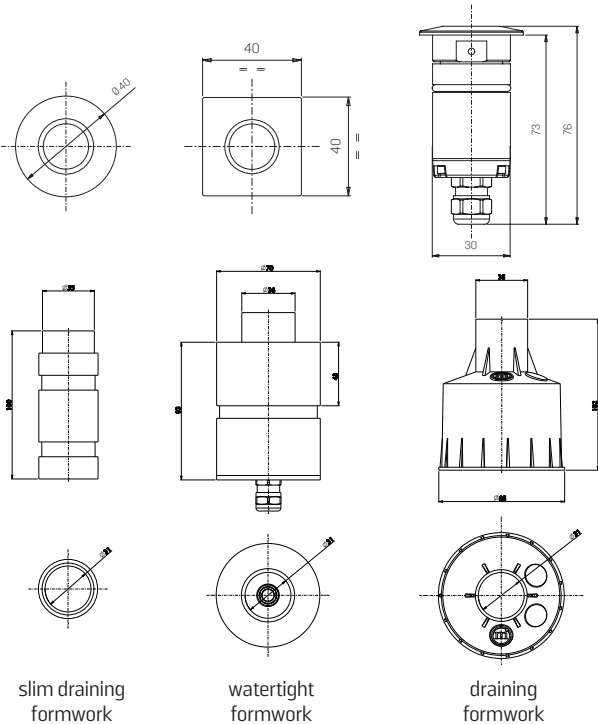

INSTRUCTIONS FOR FIXING TO THE CEILING OR PLASTERBOARD WALLS

- ① Remove the indicated O-ring and apply the plasterboard spring (accessory cod. CEAZZ015)

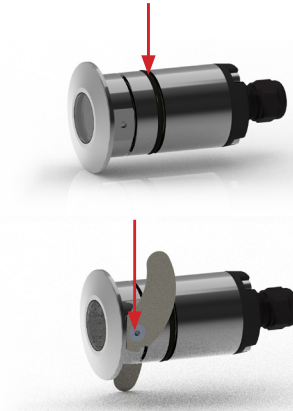

- ② Make a hole in the plasterboard of the indicated size and insert the spotlight until the complete passage of the spring beyond the hole

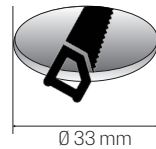

GROUND FIXING WITH FORMWORK

- ① Prepare a housing of the formwork so that the upper edge is perfectly coplanar to the floor level.

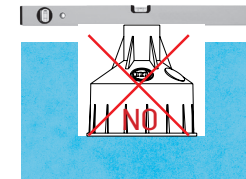
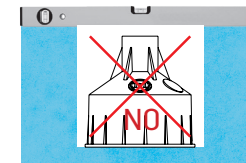
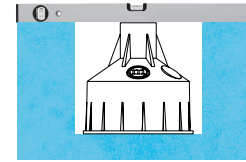

- ② Grease the O-ring with silicone grease to facilitate insertion into the formwork



- ③ Oceano products are tested and guaranteed IP66 / IP68. However, it is recommended to connect the product with gel moulds or IP68 connectors to avoid problems with the electrical system.

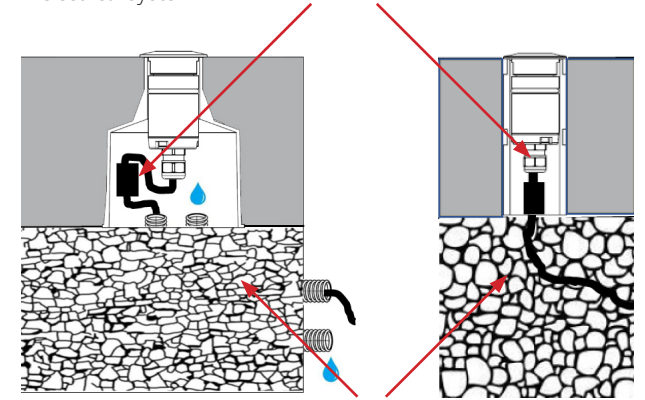

The bottom of the formwork must be in contact with draining material in order not to allow water to stagnate for long periods and to facilitate drainage through pipes.

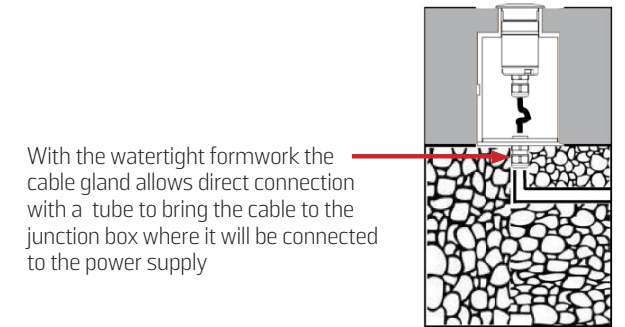

With the watertight formwork the cable gland allows direct connection with a tube to bring the cable to the junction box where it will be connected to the power supply

Parallel connection instruction

